

RT303 Rotary Temperature Transmitter (850-355)

The RT303 rotary temperature transmitter is a digital system designed to accurately transmit temperature data from RTD sensors embedded in a heated godet roll shell. The system consists of three components: The **RT303R** rotary assembly, the **RT300S** stationary assembly, and the **RT303C** controller interface assembly.



Installation

- Slide the RT303R rotary assembly onto shaft with steel base toward motor. Tighten the (2) 1/4 20 compression screws (alternating from one screw to the other) to lock assembly onto shaft.
 Note: The RT303R requires proper positioning on the shaft; see Step 5 below for details.
- Review the drawing below for wiring the RTD connections onto the RT303R rotary assembly. Secure leads with the 4-40 x 1/4" socket head cap screws provided.
- IMPORTANT!** Pull excess RTD leads towards the front of the godet roll to be stored under the godet cover. This prevents lead wires from rubbing against inside cover of RT300S stationary housing during rotation.
- Carefully position the RT300S stationary housing over shaft-mounted RT303R transmitter and mount it to the motor.
- IMPORTANT!** Refer to the diagram below to verify correct axial spacing between rotor and stator using either of the following methods:

Visual Alignment: sight the outer face of the rotor through the side ventilation holes in the stator.

Measured Alignment: insert a steel scale through the ventilation slots in the cover of the stator and measure 31.75 ± 3.2 mm from the stator (RT300S) cover to the outer face of the rotor.

- DIN rail (35mm) mount the RT303C current controller interface at a convenient location. **CAUTION: To promote airflow and prevent overheating, the RT303C must have at least 1 inch clearance above and below the enclosure.**
- Connect one end of the provided coax cable to the BNC plug on the RT300S stationary housing and the other end to the BNC plug on the RT303C.
- Connect a power source to the proper terminals indicated on the RT303C. Acceptable power is 22-35VDC or 17-27VAC. **CAUTION: Power source must be isolated from current output.**
- Connect the 4-20mA current loop (from the customer's process controller) to the current source terminals indicated on the RT303C.
- Allow a 30 second start up.

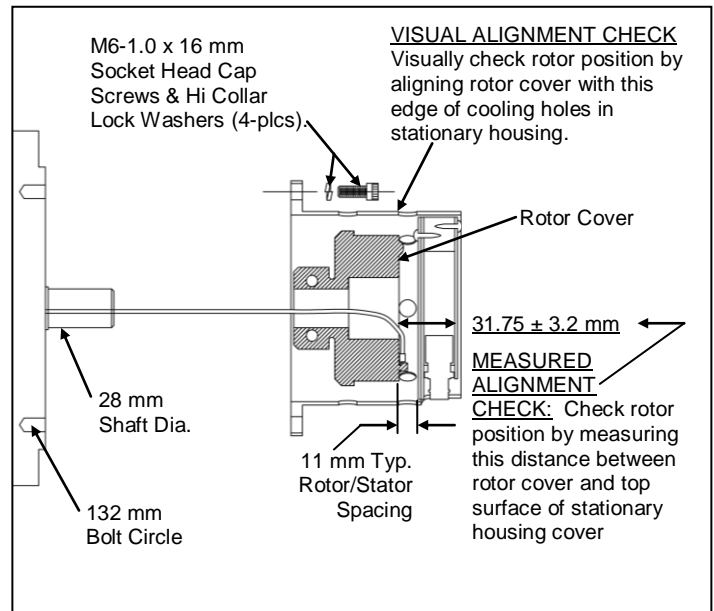

Installation Diagram

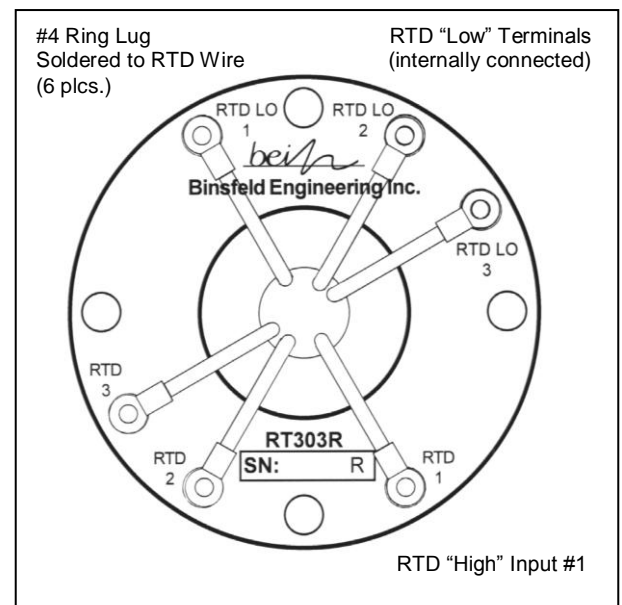

Rotor/RTD Wiring Diagram

RT303 Rotary Temperature Transmitter (850-355)

Troubleshooting

In normal operating mode the Power status light, the Data status light and the CH status light are all on solid. In error mode, one or more of the LED's on the RT303C Controller Interface will flash and a high temperature signal (approximately 24 mA) will be output. Refer to the table below when troubleshooting an error mode event.

<u>Power Status</u>	<u>Condition</u>	<u>Corrective Action</u>
On solid	Stator and rotary power in spec	---
Flash fast (5Hz)	Rotary power out of spec	Check rotor/stator spacing, and coaxial connections
Flash slow (2Hz)	Stationary power out of spec	Check power source
Off	System not powered	Check power source, and power connections
10 sec on/1 sec off [Data light off, RTD light(s) blinking]	Insufficient rotary power or data not received (Rotor Reset mode)	Check rotor/stator spacing, and coaxial connections
<u>Data Status</u>	<u>Condition</u>	<u>Corrective Action</u>
On solid	Digital transmission is error-free	---
Flickering	Intermittent transmission errors	Check rotor/stator spacing, coax connections
Off	Data not received	Check rotor/stator spacing, and coaxial connections
<u>Ch 1 Status</u>	<u>Condition</u>	<u>Corrective Action</u>
On solid	No errors detected	---
Flash fast (5Hz)	Rotary side error: RTD out of range (including open or shorted)	Check RTD, connections
Flash slow (2Hz)	Open circuit in 4-20mA loop continuity of current loop	Check connections and

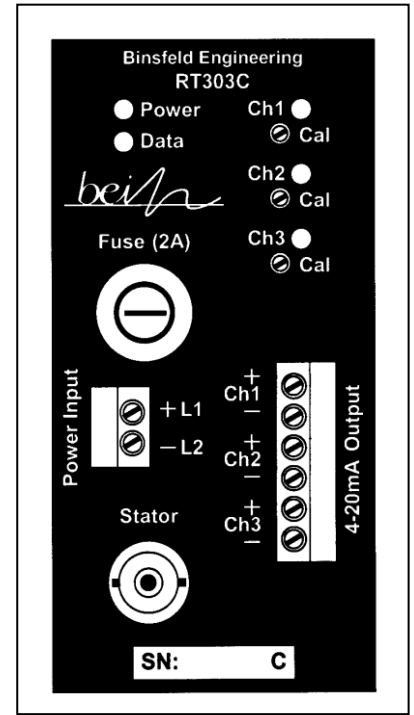

Status Indicators & I/O Diagram

If the status lights do not agree with conditions listed above, remove power to the RT303C for 5 seconds, and then restore power (to reset the digital circuitry). Go to <http://www.binsfeld.com/temptrak/rt300/> for more trouble shooting aids.

Specifications

Rotor:	Number of sensors: 1 - 3
	Sensor connection: #4-40 screw terminals with socket-head cap screws
	Input sensor type: PT100 RTD (100 Ω at 0° C, $\alpha=$.00385, two wire)
	Sensor range: 0 – 300° C
	Speed: 10,000 RPM
Stator:	Connector: Coaxial interconnect (BNC)
Controller Interface:	Output connection: Quick connect screw terminal block.
	Output signal: 4-20 mA (Linear with 0 - 300° C)
	Power input: 22-35 VDC or 17-27 VAC; 2A max, 0.5A nominal
	Max load resistance: 400 Ω
General:	Accuracy (typical error): \pm 0.30% span over operating temperature range
	Operating temperature: 0 – 100° C
	Humidity: 0-90% RH, non-condensing

This document is subject to change without prior notification.

Warranty

Binsfeld Engineering Inc. warrants this product to be free from defective materials and workmanship for a period of five years from the date of delivery to the original purchaser and that this product will conform to specifications and standards published by Binsfeld Engineering Inc. Upon evaluation by Binsfeld Engineering Inc., any product found to be defective will be replaced or repaired at the sole discretion of Binsfeld Engineering Inc. Our warranty is limited to the foregoing. Binsfeld Engineering Inc. disclaims any warranty of merchantability or fitness for intended purpose.